

# DESIGNING FLEXIBLE LNG PLANTS

**Jonathan Berg,  
Air Products and  
Chemicals, Inc., USA,**  
discusses the design  
of flexible LNG plants  
for market adaption.

**T**o produce a marketable product, the manufacturer must meet certain product specifications. For an LNG facility, these product specifications can be dictated by end-users or be a requirement for the safe storage, transportation and transfer of the LNG. Typical LNG product specifications include the following:

- Maximum carbon dioxide content.
- Maximum sulfur content.
- Maximum nitrogen content.

- Range for higher heating value (HHV).
- Maximum heavy hydrocarbon content (HHC), often expressed as maximum C5+ content.

Additionally, removing certain components prevents freeze-out in the liquefaction process that could otherwise create significant operational issues or cause damage to equipment. These include the following:

- Carbon dioxide.
- Water, either as a pure component, or within a hydrate structure.
- HHCs, particularly C6+ and aromatics such as benzene, toluene and xylenes (BTX).
- Mercury.

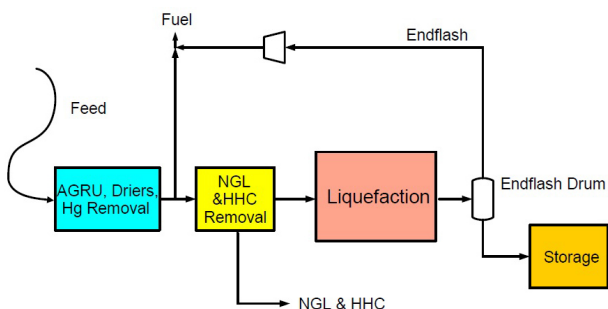

**Figure 1. Simplified liquefaction facility block diagram.**

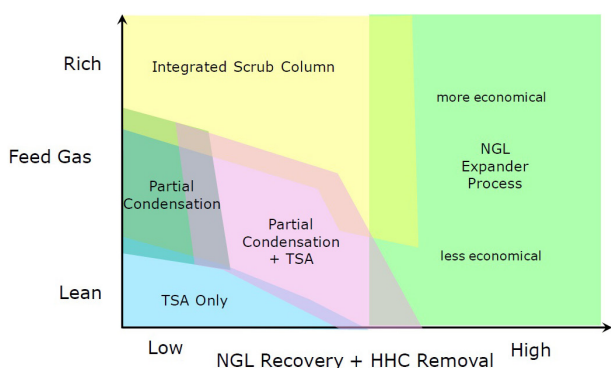

**Figure 2. NGL recovery and HHC removal technology map.**

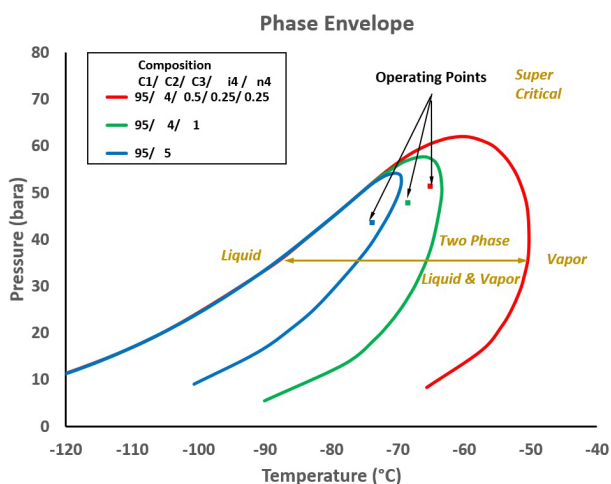

**Figure 3. Phase envelopes of various feed gas compositions.**

Figure 1 is a simplified block diagram of a natural gas liquefaction facility. Following the feed gas flow path, most baseload LNG facilities utilise an amine-based acid gas removal unit (AGRU) to remove CO<sub>2</sub> and maintain sulfur components at acceptable concentrations. Due to the nature of such an AGRU process, feed gas exiting the AGRU is saturated with water. A temperature swing adsorption (TSA) process reduces the water content of the feed gas below 1 ppm, followed by adsorption beds to remove any mercury present. While there are obviously many technical considerations within this 'simple' blue block in Figure 1, this article will focus on the remaining separations required, including their integration and synergies with liquefaction to ensure an adequately flexible design that can meet the needs of today's evolving LNG market.

One remaining separation is the natural gas liquids (NGL) and HHC components. These condense at warmer temperatures than methane, so their separation either occurs upstream of, or is integrated with, the liquefaction process. This separation must be performed in almost every facility for at least one of the following reasons:

- Adjust the LNG HHV.
- Recover valuable NGL byproducts.
- Prevent freezeout/precipitation of HHCs during liquefaction or in the LNG.
- Produce the liquefaction process refrigerants.

In some cases, the expected nitrogen content of the feed gas over the life of the plant will exceed the LNG product specification. Because nitrogen condenses at a colder temperature than methane, any separation required will occur after liquefying the bulk natural gas stream. The endflash drum depicted in Figure 1 is a very simple means of rejecting nitrogen from the LNG. If helium is present in the natural gas, it would also be removed post liquefaction, as it condenses at a much colder temperature than methane. Helium, while perhaps only present as a few hundred ppm in natural gas, is a very valuable byproduct and usually can be recovered from the liquefaction process with minimal additional capital investment, and no measurable process efficiency penalty.<sup>1</sup>

## NGL and HHC removal options and considerations

There are numerous technologies and configurations available to separate NGL and HHC components from natural gas. Typical options considered include the following:

- NGL extraction process upstream of the liquefaction unit.
- Scrub column integrated with the liquefaction unit.
- Partial condensation integrated with the liquefaction unit (can be combined with a stripping column).
- TSA adsorption process upstream of the liquefaction unit.
- Combined partial condensation and TSA adsorption process integrated with the liquefaction unit.

Careful consideration should be given to the specific project objectives and constraints to choose the best solution. The technology map presented in Figure 2 can help guide which process(es) are appropriate for the expected feed gas composition, NGL recovery objectives and HHC removal requirements.<sup>2</sup> For a flexible plant design, variability of the feed gas composition, both on a short-term and long-term basis, must be evaluated. Figure 3

illustrates how relatively small changes in composition can have a dramatic effect on the resulting phase envelopes. Because the operating point for any vapour-liquid separation process (e.g. NGL extraction, scrub column, partial condensation) must be within the two-phase region of the envelope, such composition changes may require an equally dramatic adjustment to the operating point. It is important that the process supplying refrigeration for any rectifying section condenser be able to provide that refrigeration at the required temperature. As an example, a pure component propane refrigerant circuit used to cool a scrub column condenser cannot cool the column overhead below approximately  $-35^{\circ}\text{C}$  before the propane compressor suction must operate below atmospheric pressure – the boiling point of propane at 1 atm is  $-42^{\circ}\text{C}$ . This level of refrigeration may be acceptable for a rich feed gas, but can become problematic for a lean feed gas, or one that becomes leaner over time.

For processes integrated with the liquefaction unit (i.e. integrated scrub column), any pressure or temperature adjustments required to achieve the proper separation will disturb the liquefaction process. Due to the large heat transfer duties associated with liquefaction, the system also has a significant amount of thermal inertia. If rapid and/or unpredictable composition changes are anticipated, such as the pipeline feed concentrations illustrated in Figure 4 and Figure 5, it may be impractical to quickly adjust the operating point. In this case, either a robust and flexible process is necessary to accommodate a wide range of feed gas compositions, or alternatively, the initial operating point must be selected to work across the range of expected feed gas compositions. Inherent to the latter solution is that, for most feed gas compositions, the liquefier will not operate at its peak efficiency. For example, increasing the feed pressure generally improves liquefaction efficiency, as can be seen in Figure 6.<sup>3</sup> Operating an integrated scrub column at 45 bara to accommodate all compositions in Figure 3 means there is unrealised LNG production (or excess power consumed) during the periods with richer feed gas compositions. An upstream, standalone NGL recovery unit allows liquefaction to occur at any operating pressure, while a combined partial condensation and TSA unit also offers flexibility to handle wide feed gas variations.<sup>2</sup> An economic analysis should be performed to evaluate if the additional LNG production obtained justifies installation of such technologies.

## Nitrogen removal considerations including helium recovery

Due to their low normal boiling points (NBP), both helium and nitrogen condense at colder temperatures than methane. It is, therefore, logical to use vapour-liquid-equilibrium (VLE) to separate them from LNG either with or after the natural gas liquefaction process.

- Helium NBP:  $-268.9^{\circ}\text{C}$ .
- Nitrogen NBP:  $-195.8^{\circ}\text{C}$ .
- Methane NBP:  $-161.5^{\circ}\text{C}$ .

Nitrogen separation technologies typically considered for LNG facilities include the following<sup>4</sup>:

- LNG flash drum (note, this could include an endflash drum and/or flash directly in the LNG storage tank).
- Nitrogen stripping column.
- LNG flash drum with nitrogen rejection unit (NRU).

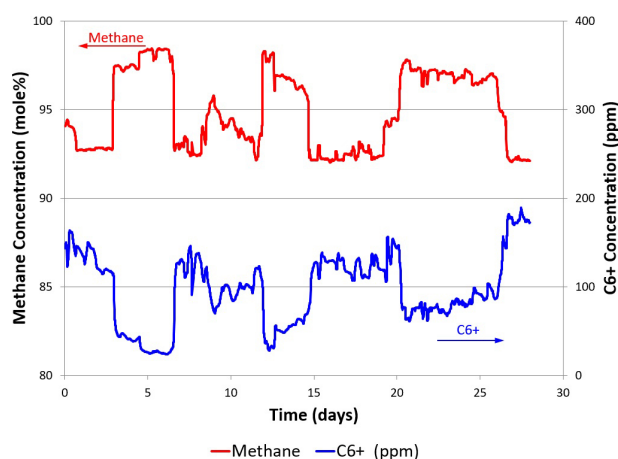

Figure 4. Pipeline #1 feed composition.

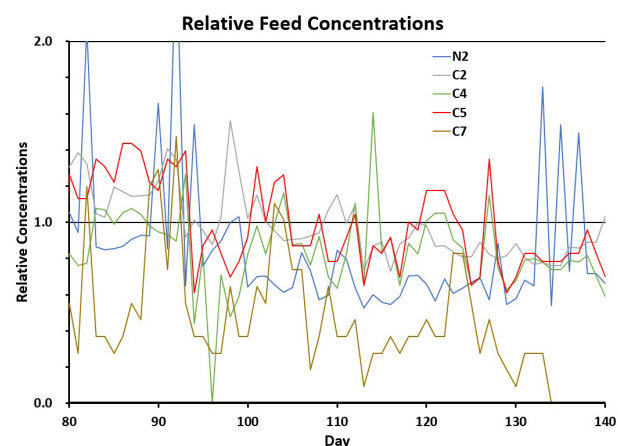

Figure 5. Pipeline #2 feed composition.

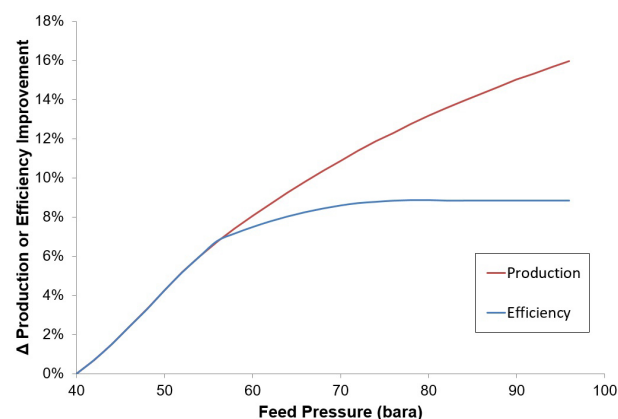

Figure 6. Effect of feed pressure on LNG production and overall liquefaction specific power.

- Nitrogen stripping column with NRU.
- Nitrogen rectifier column.

Because the vapour stream from a single stage of separation (i.e. LNG flash drum) or even a nitrogen stripping column will still contain a large fraction of methane, this stream often satisfies the facility fuel demand. While somewhat counter-intuitive, sourcing fuel gas from endflash (rather than warm, high pressure feed gas) actually improves the overall liquefaction efficiency.<sup>5,6</sup> Therefore, the technology selected

for nitrogen removal is generally a function of the expected range of nitrogen concentrations in conjunction with the facility fuel demand. Figure 7 illustrates appropriate nitrogen removal technologies as a function of these parameters. It is worth noting that the selection of the refrigerant compressor driver(s) is very important, because it sets both the amount and quality of the fuel gas required. Electric motors supplied from a local power grid do not require any fuel gas, whereas gas turbine (direct drive and indirect drive through onsite electricity generation) and steam turbine drivers require a significant amount of fuel gas. The allowable nitrogen concentration in the fuel gas also depends on the driver type. The process efficiency of the liquefaction technology selected then has a compounding effect on the fuel gas demand. Due to the interactions, synergies and constraints among various technology choices within an LNG facility, it is important to consider both upstream and downstream impacts when choosing technologies.

While typically present in much smaller quantities than nitrogen, helium is another impurity often found in natural gas, particularly in certain geographic locations. However, due to its low concentration, inert nature and the specialised analytical techniques necessary to definitively detect its presence, helium is sometimes overlooked. If present in sufficient quantities, helium recovery presents a significant opportunity to improve an LNG opportunity's economics. The economic evaluation usually is quite simple and reduces to the quantity of helium available to recover – effectively the facility throughput multiplied by the helium

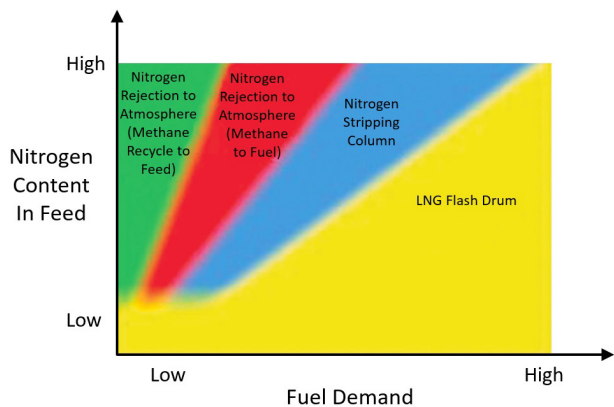

Figure 7. Nitrogen removal options.

concentration in the feed gas. Generally, 150 million – 200 million standard ft<sup>3</sup>/yr is sufficient to justify recovery, although this threshold may be as low as 50 million standard ft<sup>3</sup>/yr for US facilities.<sup>1</sup> This equates to feed gas concentrations of only a few hundred ppm for large baseload LNG facilities.

With its very cold boiling point of -268.9°C, helium is easily separated from LNG using a single stage flash drum (note, this helium recovery flash drum would be in addition to the LNG flash drum previously discussed), and much of the world's helium supply is obtained in this manner. By adjusting the pressure of the helium recovery flash drum (typically in the 2 – 5 barg range), helium recoveries of >90% are usually achievable. The crude helium stream is upgraded and purified in a separate processing unit for export as a valuable byproduct. Any contained methane in the crude helium stream can then be returned to the LNG facility as fuel gas.

Despite the relative ease of separating helium from the bulk natural gas stream, and minimal capital investment required to do so (single flash drum and associated valving and piping), upfront planning and coordination is critical. In addition to helium being overlooked in the feed gas, the extremely large scale of LNG facilities can make helium recovery an afterthought during the initial design phase. That same extremely large scale also complicates retrofit efforts, as any downtime required for implementation would have huge financial ramifications. Proper analysis of the expected feed gas composition is essential to determine if any helium recovery infrastructure (or even tie-ins for future recovery) should be installed. Special consideration should be given to facilities using pipeline feed gas, as it may be supplied by many different sources that change over time.

## Liquefaction process flexibility

There are a few fundamental decisions that must be made when selecting a liquefaction process. These very basic decisions include the following:

- Facility and/or liquefaction train size.
- Liquefaction refrigerant type:
  - ◆ Pure component, including N<sub>2</sub> and C<sub>1</sub> refrigerant processes.
  - ◆ Mixed refrigerant (MR).
- Precooled or single refrigerant processes.

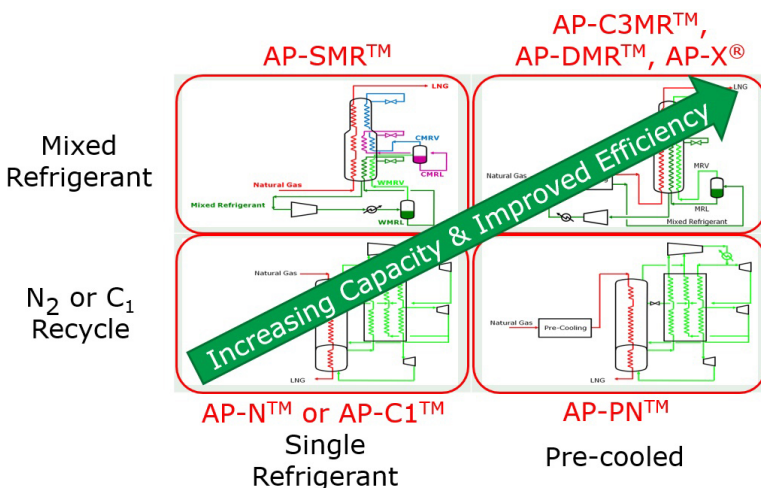

Figure 8. Air Products' liquefaction process offerings.<sup>7</sup>

As noted in Figure 8, MR processes can offer a significant efficiency benefit compared to vapour expansion cycles. However, MR processes require the extraction or purchase of those refrigerants, as well as onsite storage. Likewise, precooled processes offer an efficiency benefit at the expense of the additional equipment associated with a separate precooling refrigeration circuit. By shifting a portion of the refrigeration duty to a separate refrigeration circuit, precooled processes also can accommodate higher production for a given main cryogenic heat exchanger (MCHE) size. Additionally, the improved efficiencies of both MR and precooled processes enable even larger LNG train sizes, as the amount of circulating refrigerant per unit of LNG produced decreases. The overall project objectives and constraints generally guide these basic decisions. Train capacities over 1 million – 2 million tpy typically justify the

additional capital investment required for MR and precooled processes, while lower capacities or refrigerant sourcing/storage concerns might push an owner to choose refrigerants containing N2 or C1 only.

Once the type of liquefaction process is selected, another major decision is the driver to be used for the refrigeration compressors. Traditional drivers in the LNG industry have been steam turbines, gas turbines (both frame and aeroderivative), and electric motors. The configuration and number of drivers required will then be a function of the available driver power, train size, liquefaction process selected and the corresponding process efficiency for the given feed gas pressure and ambient conditions.<sup>8</sup>

Over the last 30 years, LNG trains have increased in size from under 3 million tpy to nearly 8 million tpy. As the technology improves and advances, it naturally makes sense to exploit all available economies of scale. However, equipment can approach practical constraints or diseconomies of scale with larger LNG trains. One example is the required refrigerant compressors' aerodynamics, such as tip (or peripheral) Mach number and inlet flow coefficient, which may exceed well-referenced designs as the driver power increases to accommodate larger LNG trains.<sup>9</sup> Parallel compression strings can help alleviate such constraints to debottleneck the capacity attainable in a single LNG train. They also have the potential to extend the range of efficient turndown, which can be important for certain business models in today's evolving LNG market.

Recent advances in compressor driver arrangements have enabled parallel compression strings to be utilised more readily. Probably the most notable example is the arrangement with all compression services on a single shaft and then duplicated in parallel. Figure 9 depicts a 2 x 50% arrangement that has been implemented in four trains using the AP C3MR™ process.<sup>10,11</sup> While such arrangements increase the number of compressor casings, an important benefit is seamlessly shifting power between precooling and liquefaction compression services. This flexibility is particularly useful in climates with wide ambient temperature variations that result in large swings in the required precooling duty, as it allows for increased utilisation of the overall available power installed.<sup>12</sup> Additional methods to increase power utilisation over a broad range of ambient temperatures, such as compressor inlet guide vanes (IGVs), are discussed by Ott et al.<sup>5</sup>

Further, parallel compression strings within a single liquefaction train offer a unique, synergistic benefit. Provided common modes of failure are minimised and a robust parallel compressor control scheme is implemented to prevent sympathetic trips among the compression strings, there is a very high probability that one compression string will always be operational. For a process that chills a product to -160°C, this allows equipment that operates at -160°C to continue operating at -160°C, even when most compression trips occur. Keeping equipment cold and operating eliminates the costly time expenditure (and possibly flaring) required to cool it down – or even warm it



**LPMR = Low Pressure MR Compressor, C3 = Propane Compressor, HP MR = High Pressure MR Compressor**

**Figure 9.** 50% parallel AP-C3MR™ LNG process.

up and then cool it down – in the controlled manner that is otherwise necessary following a trip.

## Conclusion

The evolving LNG market simultaneously presents many opportunities and challenges that demand robust and flexible solutions. Determining the optimal combination of solutions is not always simple, as there are often interactions and synergies among technology choices and specific project constraints. One size certainly does not fit all, so close collaboration among the owner, EPC contractor, process licensor and equipment suppliers will help facilitate the best overall solution for any LNG project. [LNG](#)

## References

1. NELSON, W., CAO, J., SANDERSON, C. and PLOEGER, J., "A Fresh Look at Helium Recovery from LNG", LNG 2019.
2. SCHMIDT, W. P., CHEN, F., and OTT, C. M., "Advances in Removing Heavy Hydrocarbons", Gastech 2018.
3. SCHMIDT, W. P., OTT, C. M., LIU, Y. N. and KENNINGTON, W. A., "How the Right Technical Choices Lead to Commercial Success", LNG 16.
4. OTT, C. M., ROBERTS, M. J., TRAUTMANN, S. R. and KRISHNAMURTHY, G., "State-Of-The-Art Nitrogen Removal for Natural Gas Liquefaction: New Solutions to Meet Market Needs", Gastech 2014.
5. OTT, C., BEARD, J. and PEARSALL, R., "Debottlenecking: Getting the Most Out of Your LNG Plant", Gastech 2018.
6. BERG, J. and LIU, Y. N., "Maximizing LNG Capacity for Liquefaction Processes Utilizing Electric Motors", 2012 AIChE Spring Meeting.
7. BUKOWSKI, J. D., LIU, Y. N., PILLARELLA, M. R., BOCCELLA, S. J., KENNINGTON, W. A., "Natural Gas Liquefaction Technology for Floating LNG Facilities", LNG 17.
8. KRISHNAMURTHY, G., ROBERTS, M. J. and WEHRMAN, J. G., "Drive your LNG project to success with optimal machinery selections from Air Products of US", *LNG Journal*, (May 2015).
9. OTT, C. M., SCHMIDT, W., WEHRMAN, J. and DALLY, J., "Large LNG Trains: Technology Advances to Address Market Challenges", Gastech 2015.
10. OTT, C., CHASNYK, I., KAART, S., BLADANET, C., LAFLOTTE, B., LE-RIDANT, G., DELVA, B. and ZUCCHI, O., "Yamal LNG: Meeting the Challenges of Natural Gas Liquefaction in the Arctic", LNG 2019.
11. BOCHEREL, P. and STROHMAN, J., et al., "Converting Dominion Cove point LNG into Bidirectional Facility", LNG 18.
12. SCHMIDT, W. P., OTT, C. M., LIU, Y. N. and WEHRMAN, J. G., "Arctic LNG Plant Design: Taking Advantage of the Cold Climate", LNG 17.